

# INSTRUCTION MANUAL

R. L. DRAKE  
MODEL

## **R-4B** RECEIVER

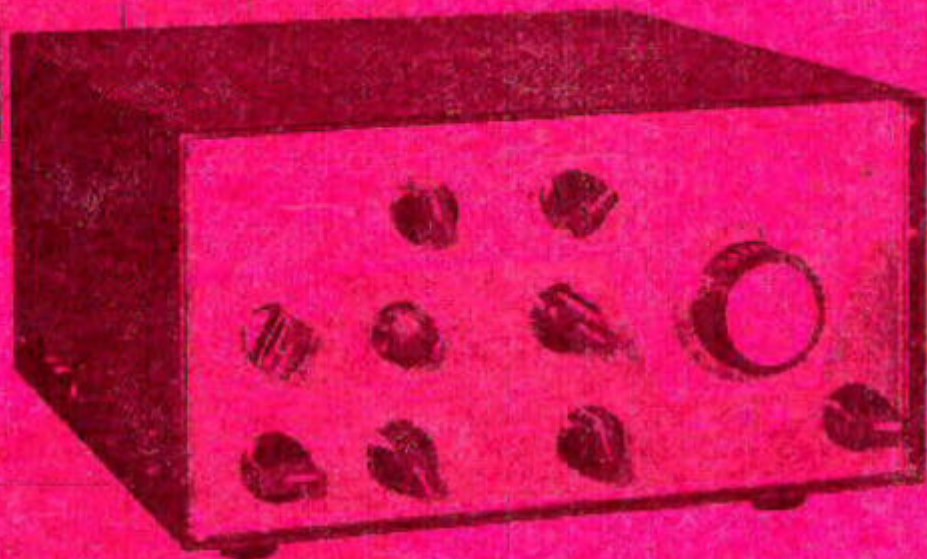

© 1953 R. L. DRAKE

## TABLE OF CONTENTS

Specifications		1-3
 <u>SECTION I, General Description</u>		
1.1	Introduction	4
1.2	Auxiliary Equipment	4
1.3	General Electrical Characteristics	5
 <u>SECTION II, Installation</u>		
2.1	Unpacking	6
2.2	Locating and Mounting	6
 <u>SECTION III, Control Functions</u>		
3.1	Front Panel	10
3.1.1	Function	10
3.1.2	Passband	10
3.1.3	Main Tuning Dial	10
3.1.4	Main Tuning Knob	10
3.1.5	A.F. Gain	11
3.1.6	SSB/CW-AM	11
3.1.7	Notch	11
3.1.8	R.F. Gain	11
3.1.9	Pre-selector	11
3.1.10	Band	12
3.1.11	XTALS	12
3.1.12	S-Meter	12
3.2	Side Panel	12
3.2.1	XTAL/VFO	12
3.2.2	S-Meter Zero	12
3.2.3	Notch Adjust	13
3.2.4	Phone Jack	13
3.3	Rear Panel	
3.3.1	ACC. Power	13
3.3.2	Inj.	13
3.3.3	Mute	13
3.3.4	Anti-Vox	13
3.3.5	Spkr.	13
3.3.6	ANT.	13
 <u>SECTION IV, Operation</u>		
4.1	Basic Control Settings	14
4.2	SSB or DSB Suppressed Carrier Reception	14
4.3	CW Reception	14
4.4	AM Reception	14

## TABLE OF CONTENTS (cont'd.)

<u>SECTION IV, Operation (cont'd.)</u>		
4.5	RTTY Reception	15
4.6	Noise Blanker	15
4.7	Notch	15
4.8	Dial Calibration	16
4.9	Additional Tuning Ranges	17
4.10	Fixed Frequency Operation	18
4.11	VHF Reception	18
<u>SECTION V, Principles of Operation</u>		
5.1	R.F. Amplifier	20
5.2	Pre-mixer	20
5.3	First Mixer	20
5.4	Second Mixer	20
5.5	I.F. System	21
5.6	Detection Systems	21
5.7	Audio Output	21
5.8	AVC System	21
5.9	S-Meter	23
5.10	Noise Blanker	23
5.11	Crystal Calibrator	24
5.12	Power Supply	25
5.13	VFO Indicator Light	25
5.14	Block Diagram	25
<u>SECTION VI, Servicing</u>		
6.1	Removing Covers	27
6.2	Tube Replacement	27
6.3	Troubleshooting	27
6.4	Alignment Instructions	27
6.4.1	25 KHz Calibrator	30
6.4.2	50 KHz Oscillator	30
6.4.3	50 KHz I.F.	30
6.4.4	Crystal Filter and Filter Match Transformer	31
6.4.5	5595 KHz Oscillator	31
6.4.6	Antenna, R. F., and Injection Circuits	32
6.4.7	Notch Filter	33
6.4.8	Passband Tuner	33
6.4.9	Bias and S-Meter	35
<u>ILLUSTRATIONS</u>		
Figure 1	Using the R-4B with the TR-4 transceiver	7
Figure 2	Mounting Options	7
Figure 3	Front View of R-4B	8
Figure 4	Rear View of R-4B	9
Figure 5	Accessory Crystal Frequencies	19
Figure 6	Preselector Tuning	22

TABLE OF CONTENTS (cont'd.)

ILLUSTRATIONS (cont'd.)

Figure 7	Selectivity Curves	22
Figure 8	Notch Effect	22
Figure 9	Block Diagram of R-4B	26
Figure 10	Voltage Chart	28
Figure 11	Resistance Chart	29
Figure 12	Top View of R-4B Chassis	36
Figure 13	Bottom View of R-4B Chassis	37
Schematic Diagram	Fold-out inside back cover	

## SPECIFICATIONS

**FREQUENCY COVERAGE:** Covers 3.5 to 4.0 MHz, 7.0 to 7.5 MHz, 14.0 to 14.5 MHz, 21.0 to 21.5 MHz, and 28.5 to 29.0 MHz.

**ACCESSORY COVERAGE:** Ten accessory crystal sockets are provided. Coverage of any ten additional 500 KHz ranges between 1.5 and 30 MHz (except between 5.0 and 8.0 MHz) can be added by installing accessory crystals.

**SELECTIVITY:** The R-4B tunable passband filter provides four passbands. With the selector set to .4, the bandwidth is .4 KHz at 6 dB down and 2.6 KHz at 60 dB down. Set at 1.2, bandwidth is 1.2 KHz at 6 dB down and 4.8 KHz at 60 dB down. Set at 2.4, bandwidth is 2.4 KHz at 6 dB down and 8.2 KHz at 60 dB down. Set at 4.8 KHz, bandwidth is 4.8 KHz at 6 dB down and 20 KHz at 60 dB down.

Selectivity switching is independent of detector and AVC switching.

**INTERMEDIATE FREQUENCIES:** First is 5645 KHz with crystal lattice filter, second is 50 KHz with tunable LC filter.

**STABILITY:** After warm up, frequency will not drift more than  $\pm 100$  Hertz. Line voltage variation of  $\pm 10\%$  will not cause frequency shift in excess of 100 Hertz.

**SENSITIVITY:** 10 dB signal-plus-noise to noise ratio obtained on any amateur band with less than a .25 microvolt signal on the antenna.

**MODES OF OPERATION:** SSB, CW, AM, RTTY

**SPURIOUS RESPONSES:** Image rejection over 60 dB. I.F. rejection over 60 dB on amateur bands. Internal spurious response less than the equivalent of a 1 microvolt antenna signal on all amateur bands.

## SPECIFICATIONS

AVC: Amplified-delayed AVC with slow (750 milliseconds) or fast (25 milliseconds) discharge, and less than 100 microseconds charge time. A 60 dB change in R. F. input causes less than 3 dB change in audio output.

INPUT IMPEDANCE: 52 ohms nominal

OUTPUT IMPEDANCE: 4 ohms to speaker,  
5000 ohms anti-vox.

AUDIO OUTPUT: 0.5 watt at AVC threshold, 1.5 watts maximum.

POWER CONSUMPTION: 60 watts, 120/240 volts A. C., 50/60 Hertz.

SIZE: 5.5 inches high, 10.75 inches wide, 12.25 inches deep overall, weight 16 pounds.

CALIBRATION: Better than  $\pm 1$  KHz when calibrated at nearest 100 KHz calibration point.

HUM & NOISE: Greater than 60 dB below rated output.

## SPECIFICATIONS

### TUBES AND SEMICONDUCTORS:

<u>Symbol</u>	<u>Type</u>	<u>Function</u>
V1	6BZ6	R. F. Amplifier
V2	6HS6	First Mixer
V3	12BE6	Second mixer and crystal oscillator
V4	12BA6	First I.F. Amplifier
V5	12BA6	Second I.F. Amplifier
V6		Symbol not used
V7	6EH5	Audio output
V8	6HS6	Pre-Mixer
V9	12BA6	Noise Blanker Amplifier
V10	12AX7A	Noise shaper and pulse amplifier
Q1	2N3394	Crystal Oscillator
Q2	FET T1S34	Variable Frequency Oscillator
Q3	2N3858	VFO Buffer Amplifier
Q4	2N3877	AVC Amplifier/detector
Q5	2N3394	AM Amplifier
Q6	2N3394	Beat Frequency Oscillator
Q7	2N3394	Audio Amplifier
Q8	T1S-34	Calibrator Oscillator
Q9	2N3394	Calibrator Trigger
Q10	2N3877	VFO Indicator Driver
D1	1N483A	Noise Pulse Detection
D2	1N483A	Noise Pulse Detection
D3	1N483A	Noise Blanking
D4, D5	1N3194	B+ Rectifiers
D6	1N3194	Bias Rectifier
D7	1N270	AM Detection
D9	1N714	Voltage Regulator
D10	1N483A	Switching Diode
D11, D12	1N270	Product Detection
D13, D15	1N483A	Steering Diode
D14	1N270	Switching Diode
D16	1N483A	Calibrator Supply Rectifier
D17	1N483A	Bias Clamping
IC1	923	Calibrator frequency divider
IC2	923	Calibrator frequency divider

SECTION I  
General Description

1.1 INTRODUCTION

The Drake model R-4B is a double conversion superheterodyne receiver, with preslector, designed for optimum reception of all types of amateur radio communications. It gives complete coverage of the 80, 40, 20, and 15 meter bands, as well as the portion of the 10 meter band from 28.5 MHz to 29.0 MHz. Additional coverage between 1.5 and 30 MHz is possible using accessory crystals. A linear permeability-tuned solid state VFO and premixed injection from a crystal-controlled high frequency oscillator give excellent stability on all bands. A crystal calibrator provides accurate frequency checkpoints at 25 KHz intervals throughout the usable range of the receiver. Selectivity may be varied with the passband tuner-filter which has four selectivity positions. Noise blanking and AVC action are controllable from the front panel.

1.2 AUXILIARY EQUIPMENT

Supplied - Shorted plug for insertion in Mute jack on rear deck when external muting is not desired. Insertion of the shorted plug is necessary for operation of Noise Blanking and Calibration circuits when external muting is not employed. Each R-4B is shipped with this plug installed in the mute jack.

Required - 4 ohm speaker and/or 600 ohm headphones.

Available - MS-4 speaker, supplied with cable and connectors, housed in cabinet matching the R-4B.

SC-6, low noise FET converter for 6 meters.

SC-2, low noise FET converter for 2 meters.

SCC-1, VHF crystal calibrator with FET.

CPS-1, solid state power supply for SC-6,  
SC-2 and SCC-1.

T-4XB transmitter, 200 watts PEP input power  
on SSB and AM, 200 watts CW.

T-4B receiver, connects to R-4B and uses its  
VFO, 200 watts PEP input on SSB, 200  
watts input CW.

AC-4, solid state power supply for T-4 or T-4X  
(can be housed in MS-4 cabinet).



SECTION I  
General Description

1.3 GENERAL ELECTRICAL CHARACTERISTICS

The R-4B operates from a nominal 115/230 volts, 50 to 60 Hertz, single phase power source. If the receiver is to be operated from a 230 volt source, the power transformer primary winding must be reconnected as indicated in the schematic diagram. Power consumption is 60 watts.

A resonant antenna having an impedance between 50 and 75 ohms will give optimum performance. When the R-4B is used with a transmitter, the transmitting antenna should be used for reception, with the antenna changeover being accomplished with an antenna relay.

A high impedance output (5000 ohms) is provided at the ANTI-VOX jack on the rear of the R-4B chassis for use with transmitters having voice control capabilities.

## SECTION II Installation

### 2.1 UNPACKING

Carefully remove the receiver from the shipping carton and examine it for evidence of damage. If any damage is discovered, immediately notify the transportation company that delivered the receiver. Be sure to keep the shipping carton and packing material, as the transportation company will want to examine them. Keeping the carton and packing is recommended in any case, as having these available makes shipping the receiver much easier should it ever be necessary to return it to the factory for service. Inspect the packing material before putting it away, to be sure you have not overlooked any accessory hardware. The hardware consists of two studs, #10-24, 5/8 inches long, and two small rubber feet.

Fill out and mail the warranty registration card.

Examine your R-4B, making sure all tubes and crystals are properly seated in their sockets. Check all switches and tuning controls for freedom of action.

### 2.2 LOCATING AND MOUNTING

The location of the R-4B is not critical, as long as care is taken to allow for adequate air circulation. Avoid extremely hot locations, such as adjacent to building heating outlets. It is recommended that a minimum clearance of one inch be maintained at each side of the R-4B. Do not cover the top of the R-4B with books, paper, or pieces of equipment.

As supplied, your R-4B sits with its base parallel to the mounting surface, and its front panel vertical to the mounting surface. With the studs and rubber feet supplied, it is possible to position the R-4B for either of two alternate viewing angles, as shown in Figure 2. To convert the R-4B to either option, the first step is to remove the bottom cover from the receiver. Remove the bottom row of three screws on each side of the receiver, and the cover can be removed. Remove the rear feet, and snap the small rubber feet into the holes just inboard from the original rear feet. For option 1, put the bottom cover back on the receiver. For option 2, remove the front feet from the receiver, invert them, and remount them on the same screws. Then thread one of the accessory studs into each of the remounted front feet. Finally, mount the feet that were removed from the rear of the receiver on the studs, and put the bottom cover back onto the receiver.

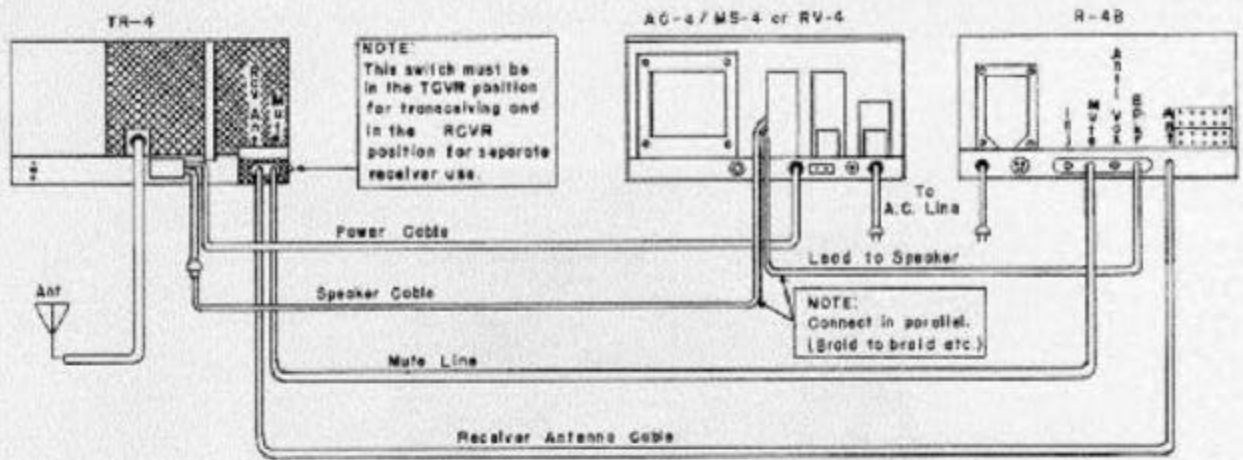

FIG. 1 USING THE R-4B WITH THE TR-4 TRANSCEIVER

### VIEWING ANGLE OPTIONS

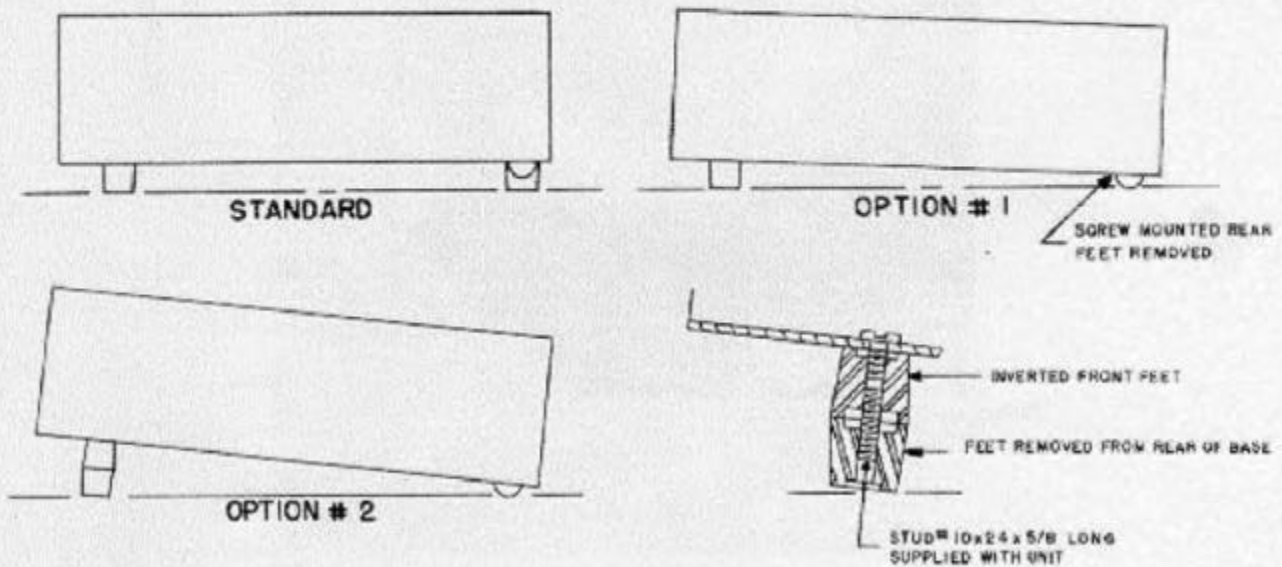

FIGURE #2

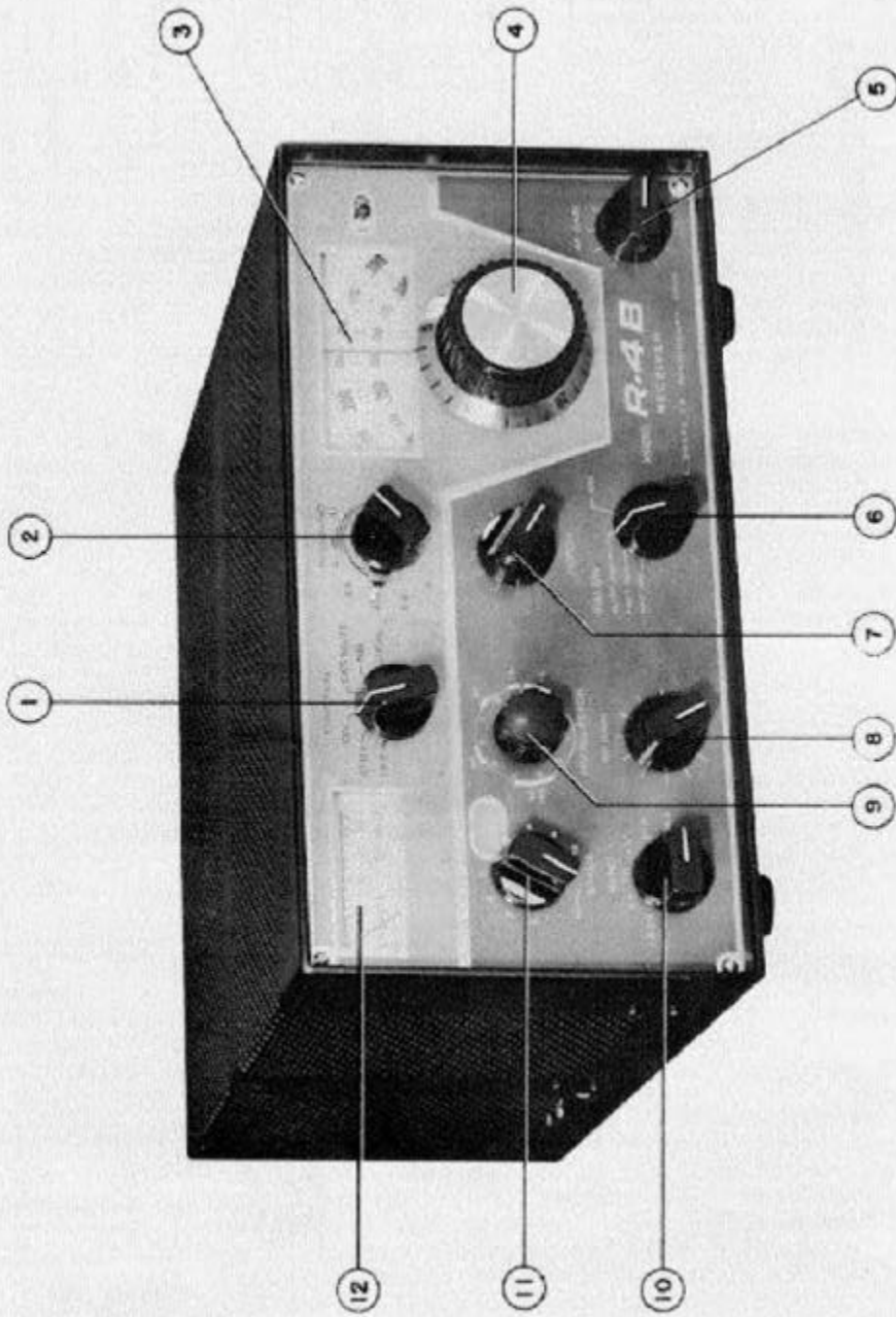

FIGURE #3 FRONT PANEL

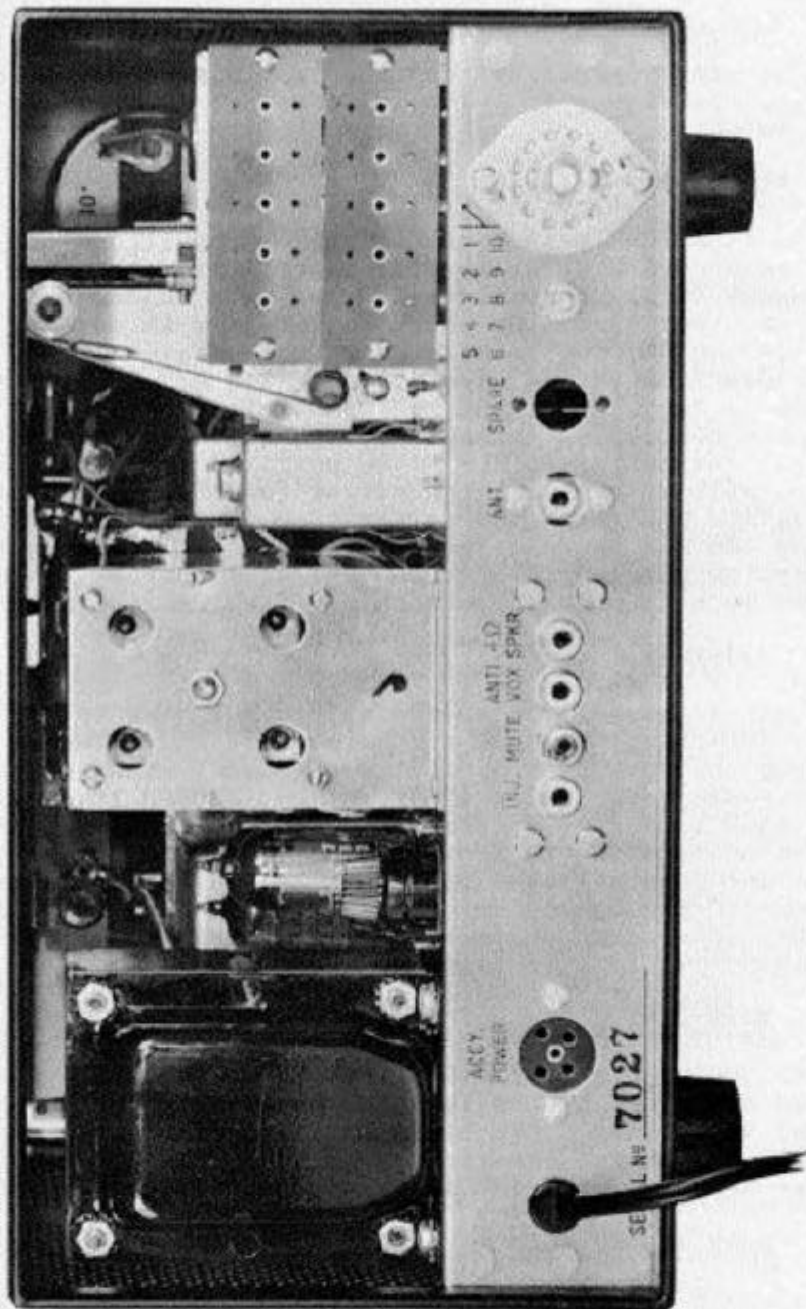

FIGURE #4 REAR VIEW

SECTION III  
Control Functions

3.1 FRONT PANEL

The front panel operating controls and dials are identified, by number, in Figure 3. The functions of these items are described below.

3.1.1 FUNCTION

With the function switch (1) in the OFF position, the primary of the power transformer is disconnected from the line cord. In the standby (STBY) position all operating voltages are applied to the receiver circuits, but the receiver is muted. With the switch in the ON position, the receiver operates unmuted regardless of external muting connections. The EXT. MUTE position is the same as the ON position, except that receiver muting is now externally controlled through the Mute jack on the rear of the chassis. Switching to the N. B. position energizes the noise blanker, without changing the muting function. Switching to the CAL position energizes the calibration circuits, again without changing the muting function. If external muting is not used, the shorting plug (supplied with the R-4B) must be inserted into the Mute jack in order to obtain N.B. and CAL operation.

3.1.2 PASSBAND

The passband control (2) is a dual control, consisting of a lever for selecting the band width desired and a tuning knob for adjusting the positioning of the passband with respect to the beat frequency oscillator (BFO). Four curved lines above the tuning knob indicate the relative width of the four passbands, with the shortest curve representing the .4 KHz bandwidth. The dots at the ends of these curved lines indicate the position of the passband tuning control for single sideband reception. The left hand dots are used for lower sideband reception, and the right hand dots are for upper sideband reception.

3.1.3 MAIN TUNING DIAL

The main tuning dial (3) contains two scales, one marked 0 to .500 and the other .500 to 1.000. Each division on the main dial is equal to 25 KHz. For bands starting with a whole number of MHz (as 7.0) the scale marked 0 to .500 is read, and for bands starting at a half MHz (as 1.5) the .500 to 1.000 scale is read.

3.1.4 MAIN TUNING KNOB

An additional scale on the skirt around the tuning knob (4), is marked from 0 to 25, and is read directly in KHz. For example, if the band selector was set to 7.0, the indication on the main tuning dial was between .025, and the first graduation above .025, and the indicated value on the skirt of the tuning knob

SECTION III  
Control Functions

was 4, the frequency would be 7,029 MHz. If the bandswitch was set at 3.5, and all other settings were as in the example just given, the scale of the main dial marked from .500 to 1.000 would be used and the frequency would be 3.529.

3.1.5 A.F. GAIN

The A. F. Gain control (5) varies the audio output from the receiver by varying the audio voltage applied to the audio amplifier stages.

3.1.6 SSB/CW-AM

This switch (6) selects the mode of reception and the AVC action. In the AM position the BFO is turned off, and diode detection with SLOW AVC is used. Three modes of reception are possible in the SSB/CW position. In all three modes a product detector and the BFO are used. The SLOW AVC position is normally used for single sideband and CW reception, with the FAST AVC position used for teletype and break-in CW. The AVC OFF is used only on CW under difficult conditions when manual operation of the R.F. Gain control may be helpful.

3.1.7 NOTCH

The notch control (7) can be used to attenuate an unwanted carrier on any mode of operation. A permeability-tuned T-notch filter is used for this purpose. Rotation of the control knob tunes this narrow-band frequency rejection filter across the receiver's I.F. Any carrier falling in the I.F. range can be attenuated by the use of this control, including the desired carrier, thus some practice and care are essential for satisfactory operation of this control. Provision is made in the R-4B for adjusting the Notch filter for optimum performance. The procedure is given in Section IV of this manual. Rotation of the Notch control during single sideband reception should correspond to the positioning of the Passband control. Thus, if the Passband control is set left of center (lower sideband reception) the Notch control should be rotated to the left to attenuate interfering carriers.

3.1.8 R. F. GAIN

This control (8) adjusts the bias applied to the R.F. amplifier tube, the two I.F. amplifier tubes, and the noise blanker amplifier tube, thus determining the overall R.F. gain of the receiver.

3.1.9 PRE-SELECTOR

Rotation of this control (9) changes the tuning of the antenna, R.F., and pre-mixer coupling coils. The outer ring of numbers,

## SECTION III Control Functions

around the base of this control indicates the general setting for the various bands. Fine adjustment for peak reception is made after the signal is tuned in. A scale calibrated from 0 through 10 is provided for logging.

### 3.1.10 BAND

This six position switch (10) selects the amateur band desired during normal operation. It also is used to select the proper R.F. circuits for the various tuning ranges when use is made of accessory crystals for other frequency ranges. Operation of the band switch during accessory operation is described in Section IV.

### 3.1.11 XTALS

In the Norm. setting of this 11 position switch (11), the proper crystal for reception of the various bands is selected by the BAND switch (except at the 1.5 setting). The numbered positions of this switch correspond to the accessory crystal sockets mounted at the rear of the receiver. When the switch is set to a numbered position, the crystal in the socket having the same number will be connected to the circuit for accessory band operation. (The range window, just to the right of the XTALS control, provides a convenient place to write in the frequency covered in each accessory band). The band switch must then be operated in accordance with the Accessory Operation instructions in Section IV.

### 3.1.12 S-METER

The S-meter (12) indicates relative signal strength, and is a convenient indicator for peaking the tuning of the receiver. The lower (left hand) portion is calibrated in S-units from S-1 through S-9. Above S-9 the scale is calibrated in decibels. Each S-unit is equal to approximately 5 dB. An S-9 signal is approximately 30 microvolts input to the antenna jack.

## 3.2 SIDE PANEL CONTROLS

### 3.2.1 XTAL/VFO

A slide switch on the left side of the chassis allows selection of crystal control for single-frequency reception or normal reception with the VFO. Loosen screw and rotate stop to operate switch.

### 3.2.2 S-METER ZERO

On the right side of the R-4B you will find two adjustments. The one nearer the front of the receiver is for adjustment of the S-meter zero. The use of this control is described in Section V of this manual.



SECTION III  
Control Functions

3.2.3 NOTCH ADJUST

The control nearer the rear of the right side of the R-4B chassis is the Notch Adjust. The use of this control is discussed in Section IV of this manual.

3.2.4 PHONE JACK

The phone jack, is located on the right hand side of the R-4B, is used when private listening is desired. Connection of the headphones automatically mutes the speaker output. While headphone impedance is not critical, a good quality set of 600 ohm phones is recommended for satisfactory reception.

3.3 REAR VIEW

The jacks on the rear of the R-4B are shown in Figure 4. The functions of these jacks are described below.

3.3.1 ACC. POWER

The accessory power socket, located at the left side of the chassis, provides power for operating accessories. Maximum load is 6.3 volts AC at 750 milliamperes and +150 volts DC at 30 milliamperes. The socket mates with a Cinch type 5AB2 plug.

3.3.2 INJ.

The phone jack marked INJ. provides a means of coupling the pre-mixer system of the R-4B to either the Drake T-4 or Drake T-4X transmitters for transceive operation.

3.3.3 MUTE

The MUTE jack provides connections for external standby-receive switching. The external circuit must isolate the mute jack center conductor from ground for standby, and connect it to the mute jack ground for receive.

3.3.4 ANTI-VOX

High impedance audio is available at the ANTI-VOX jack for use with the Anti-Vox circuit of the transmitter.

3.3.5 SPEK.

The audio output from the receiver is available at this jack. The output impedance is 4 ohms.

3.3.6 ANT.

This jack is the connection point for the antenna. The nominal impedance of the circuit is 52 ohms.

SECTION IV  
Operation

4.1 BASIC CONTROL SETTINGS

For all modes of operation with the R-4B in the "as received" condition, and with the shorting plug connected to the MUTE jack, the basic control settings are:

FUNCTION	ON
BAND	Set to desired amateur band
XTALS	NORM
NOTCH	OFF
R.F. GAIN	Fully clockwise
A.F. GAIN	Comfortable level
PRESELECTOR	Set to center of band segment marked on panel. After the desired signal is tuned in adjust for maximum S-Meter reading.
XTAL/VFO SWITCH	VFO

4.2 SSB OR DSB SUPPRESSED CARRIER RECEPTION

After making the basic settings listed above:

1. Set the PASSBAND selector level to 2.4.
2. Set the PASSBAND knob to the dot at the left end of the third curved line (from the top) for lower sideband, or to the dot at the right end of the same line for upper sideband.
3. Set the SSB/CW-AM switch to SLOW AVC.
4. Tune in a station with the main tuning control.
5. Adjust preselector for maximum S-Meter reading.

4.3 C.W. RECEPTION

Make the control settings listed in Paragraph 4.1, then:

1. Set the PASSBAND Selector lever to 1.2.
2. Set the PASSBAND knob to either of the dots at the ends of the curved line that is second from the top.
3. Set the SSB/CW-AM switch to SLOW AVC.
4. With the main tuning knob, tune in a station for pleasing audio pitch and readjust the PASSBAND knob for maximum S-Meter reading.
5. .4 position may be used advantageously under crowded band conditions.

4.4 AM RECEPTION

Make the basic control settings listed in Paragraph 4.1, then:

1. Set the PASSBAND Selector level to 4.8.
2. Set the PASSBAND knob to the center of the longest curved line.
3. Set the SSB/CW-AM switch to AM.
4. Use the main tuning knob to tune in a signal.

SECTION IV  
Operation

4.5 RTTY RECEPTION

Make the control settings listed in Paragraph 4.1 then:

1. Set the PASSBAND selector lever to 1,2.
2. Set the PASSBAND knob to the left of the dot at the left end of the curved line which is second from the top.
3. Set the SSB/CW-AM switch to FAST AVC.
4. With the main tuning knob, tune in a signal for correct indication on your terminal unit tuning indicator, and adjust the PASSBAND knob for equal S-Meter readings of both mark and space. If the station you are copying is sending "upside down" (mark low - space high) turn the PASSBAND knob so it is to the right of the dot at the right end of the second curved line, then re-tune the station with the main tuning control.

4.6 NOISE BLANKER

The noise blanker can be used on any type reception. It is most effective on short duration noise impulses, such as those generated by automotive ignition systems. The noise blanker functions only on noise pulses that have a higher level than the signal being received. Because the AVC holds the audio output constant, the noise blanker may not seem to cause the noise to decrease. However, signals undetectable without the noise blanker, can be copied when the noise blanker is used.

4.7 NOTCH

The notch can be used effectively in all modes of reception for attenuation of heterodyne interference from a carrier near the desired carrier. A permeability-tuned T-notch filter in the 50 KHz I.F. is used for this purpose. The filter produces a deep notch which can be tuned across the I. F. by rotation of the NOTCH control knob.

To obtain optimum results from the notch circuitry, it is necessary to check out the operation of the notch in accordance with the following procedure:

1. Set the R-4B controls as indicated:

<u>CONTROL</u>	<u>SET TO</u>
FUNCTION	CAL
PASSBAND	Selector lever to 2,4 or 4,8, knob to either dot on proper line.
BAND	3.5
XTALS	NORM

SECTION IV  
Operation

<u>CONTROL</u>	<u>SET TO</u>
R.F. GAIN	Fully clockwise
A.F. GAIN	Comfortable level
SSB/CW-AM	FAST AVC
NOTCH	OFF

2. With the main tuning knob, tune in the crystal calibrator signal and adjust for low pitched audio note. Adjust the preselector for a maximum S-Meter reading.
3. Rotate the NOTCH control knob until some reduction of the S-Meter reading is observed.
4. Adjust the NOTCH ADJUST control (the rear of the two controls on the right side of the R-4B) to further reduce the S-Meter reading.
5. Continue to adjust the NOTCH control knob and the NOTCH ADJUST control until a minimum S-Meter reading is obtained. Further adjustment of the notch circuit will seldom be necessary.

Positioning of the NOTCH control knob must be correlated with the position of the PASSBAND control knob. Thus, if the PASSBAND control knob is positioned left of center, then heterodynes will be eliminated when the NOTCH control knob is left of center.

On any mode of operation, an unwanted carrier is attenuated by tuning the notch across the receiver passband until the unwanted carrier is removed by the notch filter. Since the notch filter will remove the wanted carrier just as readily as an unwanted carrier, the NOTCH control must be carefully adjusted for maximum effectiveness.

#### 4.8 DIAL CALIBRATION

The quartz crystals used in the R-4B have excellent stability, but the exact frequency of any particular one may be a little above or below the design frequency. Therefore, provision has been made on the R-4B for adjusting the dial calibration to agree with the crystal in use. To set the dial calibration on a band, proceed as follows:

1. Set BAND, PRESELECTOR, and XTALS switches to the desired band.
2. Set FUNCTION to CAL.
3. Set SSB/CW-AM to SLOW AVC.
4. Tune for zero beat with the crystal calibratory signal at the 25 KHz point that is nearest the desired operating frequency.

SECTION IV  
Operation

5. Grasp the red handle at the right side of the main tuning dial window and move the tuning index line until it aligns with the nearest 25 KHz point in the tuning dial.
6. Without moving the tuning knob, turn the metal skirt at the base of the tuning knob until the zero mark aligns with the index mark on the front panel of the R-4B.

4.9 ADDITIONAL TUNING RANGES

By inserting the appropriate crystals in the accessory crystal sockets at the top rear of the chassis, it is possible to add up to 10 additional tuning ranges (each 500 KHz wide) to the coverage of the R-4B. With the exception of the band from 5.0 to 6.0 MHz, these additional ranges may be anywhere between 1.5 and 30 MHz.

Only series resonant crystals should be used for accessory coverage. Selected crystals for accessory coverage with the R-4B can be supplied by the R. L. Drake Company for \$5.00 per crystal. To determine the correct crystal frequency for any additional range, see Figure 5 on page 19, which shows the required crystal frequency and the proper BAND switch setting for the R-4B for the frequency spectrum from 1.5 to 30 MHz, except for the 5.0 to 6.0 MHz range. However, if you are going to transceive with the Drake T-4 or T-4X, the crystal selection table in the transmitting manual should be followed in selecting accessory crystals.

In order to receive with an accessory crystal, the XTAL switch of the R-4B must be set to the number corresponding to the accessory crystal socket into which the crystal was plugged. The lowest frequency of the accessory range may then be marked in the range window for reference. The marking is easily erased when crystals are changed.

The BAND switch must be set to a position which will allow the preselector to tune the desired frequency range. Recommended settings of the BAND switch are:

<u>TUNING RANGE, MHz</u>	<u>BAND switch setting</u>
1.5 to 3.0	1.5 - 3.0
3.0 to 5.0	3.5
6.0 to 10.0	7.0
10.0 to 16.0	14.0
16.0 to 23.0	21.0
23.0 to 30.0	28.5

## SECTION IV Operation

### 4.10 FIXED FREQUENCY OPERATION

Your R-4B can be locked to a particular operating frequency by plugging the appropriate crystal into the crystal lock socket on the left side of the chassis, and pushing the handle of the slide switch adjacent to the crystal socket toward the rear of the chassis. With the switch in this position, the VFO and crystal oscillator system of the R-4B will no longer control the frequency of the receiver.

Fundamental mode crystals designed for operation at parallel resonance and mounted in type HC-6/U holders should be used for fixed frequency operation. For operation at frequencies up to 9.355 MHz, the crystal frequency should be equal to the desired operating frequency plus 5.645 MHz. For operation at frequencies above 9.355 MHz, the crystal frequency should be equal to one-half of the sum of the desired operating frequency and 5645 MHz. A trimmer capacitor (C77) for tuning the crystal to the exact desired operating frequency is provided just below the crystal lock socket.

PRESELECTOR and BAND switch settings are made as described under Accessory operation.

In transceive operation with a T-4X, setting the T-4X TRANSCEIVE switch to the RCVR position will lock the T-4X to the R-4B crystal lock frequency. Setting the T-4X TRANSCEIVE switch to SEPARATE (SEP. CONT. on some units) will allow the T-4X to be VFO controlled while the R-4B remains on the crystal lock frequency. When the T-4X TRANSCEIVE switch is set to XMIT, the T-4X controls both the transmitting and receiving frequency, and the crystal lock circuit of the R-4B has no effect.

Crystals for fixed frequency operation of the R-4B can be supplied by the R. L. Drake Company. When ordering, specify that the crystals are to be used for fixed frequency operation of the R-4B.

### 4.11 VHF RECEPTION

Quality reception of 2 and 6 meters is now possible with the R-4B with the addition of the Drake Model SC-2 and SC-6 receiving converters. Utilizing field effects transistors, these converters offer a marked improvement in performance over anything previously available. See them at your dealer, or write the R. L. Drake Company for literature.

CRYSTAL FREQUENCY CHART

<u>FREQ. RANGE</u>	<u>CRYSTAL</u>	<u>BAND</u>	<u>FREQ. RANGE</u>	<u>CRYSTAL</u>	<u>BAND</u>
1.5-2.0	12.6	1.5-3.0	16.5-17.0	27.6	21.0
2.0-2.5	13.1	1.5-3.0	17.0-17.5	28.1	21.0
2.5-3.0	13.6	1.5-3.0	17.5-18.0	28.6	21.0
3.0-3.5	14.1	3.5	18.0-18.5	29.1	21.0
3.5-4.0	14.6*	3.5	18.5-19.0	29.6	21.0
4.0-4.5	15.1	3.5	19.0-19.5	30.1	21.0
* 4.5-5.0	15.6	3.5	19.5-20.0	30.6	21.0
* 5.0-5.5	17.1	7.0	20.0-20.5	31.1	21.0
6.5-7.0	17.6	7.0	20.5-21.0	31.6	21.0
7.0-7.5	18.1*	7.0	21.0-21.5	32.1*	21.0
7.5-8.0	18.6	7.0	21.5-22.0	32.6	21.0
8.0-8.5	19.1	7.0	22.0-22.5	33.1	21.0
8.5-9.0	19.6	7.0	22.5-23.0	33.6	21.0
9.0-9.5	20.1	7.0	23.0-23.5	34.1	28.5
* 9.5-10.0	20.6	7.0	23.5-24.0	34.6	28.5
* 10.0-10.5	21.1	14.0	24.0-24.5	35.1	28.5
10.5-11.0	21.6	14.0	24.5-25.0	35.6	28.5
11.0-11.5	22.1	14.0	25.0-25.5	36.1	28.5
* 11.5-12.0	22.6	14.0	25.5-26.0	36.6	28.5
12.0-12.5	23.1	14.0	26.0-26.5	37.1	28.5
12.5-13.0	23.6	14.0	26.5-27.0	37.6	28.5
13.0-13.5	24.1	14.0	27.0-27.5	38.1	28.5
13.5-14.0	24.6	14.0	27.5-28.0	38.6	28.5
14.0-14.5	25.1*	14.0	28.0-28.5	39.1	28.5
14.5-15.0	25.6	14.0	28.5-29.0	39.6*	28.5
* 15.0-15.5	26.1	14.0	29.0-29.5	40.1	28.5
15.5-16.0	26.6	14.0	29.5-30.0	40.6	28.5
16.0-16.5	27.1	21.0			

\* Supplied with receiver

FIGURE 5

SECTION V  
Principles of Operation

5.1 R.F. AMPLIFIER

Signals from the antenna are fed from J4 (ANT.) to permeability-tuned transformer T1, and are applied to the grid of V1 through the tuned circuit formed by T1 and capacitors C21 through C31. The amplified signal is coupled from the plate of V1 to the grid of V2 through the tuned circuit formed by permeability-tuned coil T2 and capacitors C1 through C11.

5.2 PRE-MIXER

The pre-mixer system includes a transistorized permeability-tuned VFO (T13), crystal-controlled oscillator (Q1), pre-mixer tube (V8), and the output circuitry consisting of T3 and T4 and the associated tuning and coupling capacitors.

The VFO is tunable from 4955 KHz to 5455 KHz. The output of the VFO is applied to the cathode of V8.

The output of crystal-controlled oscillator Q1 is applied to the grid of V8. The crystal selected to control oscillator Q1 is determined by the settings of the XTALS and BAND switches. The frequency of the crystal selected will always be such that the difference frequency obtained by heterodyning the output of the VFO with the output of oscillator Q1 will be 5645 KHz higher in frequency than the desired signal frequency.

5.3 FIRST MIXER

The output of pre-mixer V8 is coupled to the cathode of the first mixer (V2) through the permeability-tuned pre-mixer output coils T3 and T4, and their associated tuning and coupling capacitors. Heterodyning of the pre-mixer output and the R. F. amplifier output in V2 results in a difference frequency output from V2 of 5645 KHz.

Gang tuning of the RF coils (T1 and T2) and the pre-mixer output coils (T3 and T4) is used to maintain a fixed frequency relationship among these variable circuit elements.

5.4 SECOND MIXER

The cathode and the control and screen grids of the second mixer (V3) are connected in a Pierce oscillator configuration. The oscillator is crystal controlled, and operates at 5595 KHz. The 5645 KHz output of the first mixer is passed through a crystal filter (T6), applied to



SECTION V  
Principles of Operation

the signal grid of second mixer V3, and mixes with the 5595 KHz local oscillator signal, resulting in a 50 KHz difference frequency output from the second mixer.

5.5 I.F. SYSTEM

The 50 KHz output of second mixer V3 is applied to the grid of the first I.F. amplifier, V4, through the T-notch filter T8 and its associated circuitry. After amplification in V4, the 50 KHz signal is applied to the passband tuner T9. The passband tuner incorporates four LC circuits with high Q. Tuning of the passband is accomplished by ganged permeability tuning of the four inductors, and selectivity variation is accomplished by varying the coupling between the four LC circuits. Selectivity curves for the passband tuner are shown in Figure 7. Figure 8 illustrates the effect of the notch.

The output of the passband tuner is applied to the grid of the second I.F. amplifier, V5. After amplification by V5, the 50 KHz I.F. signal is applied to I.F. transformer T10.

5.6 DETECTION SYSTEMS

The signal path from I.F. transformer T10 is determined by the setting of the SSB/CW-AM switch S2. When the switch is in any of the SSB/CW positions, the beat-frequency oscillator (Q6) is turned on, generating a 50 KHz signal which is applied to product detector diodes D11 and D12, and heterodynes with the 50 KHz signal from T10, giving an audio frequency output which appears across the A.F. Gain control, R127.

Changing S2 to the AM position turns off BFO Q6 and turns on AM detector D7 and amplifier Q5. Detection is accomplished by D7, and Q5 amplifies the audio signal to a level matching the output level of the product detector before the audio is applied to R127.

5.7 AUDIO OUTPUT

A portion of the audio signal, as determined by the setting of R127, is applied to Q7, and then to the audio output tube. The output of V7 is applied to output transformer T16, and from the secondary of the output transformer to the speaker. The ANTI-VOX jack (J5) is connected to the plate of V7 through capacitor C122.

5.8 AVC SYSTEM

The AVC amplifier (Q4) is biased past cut-off with no signal input to the receiver. The base of Q4 is coupled

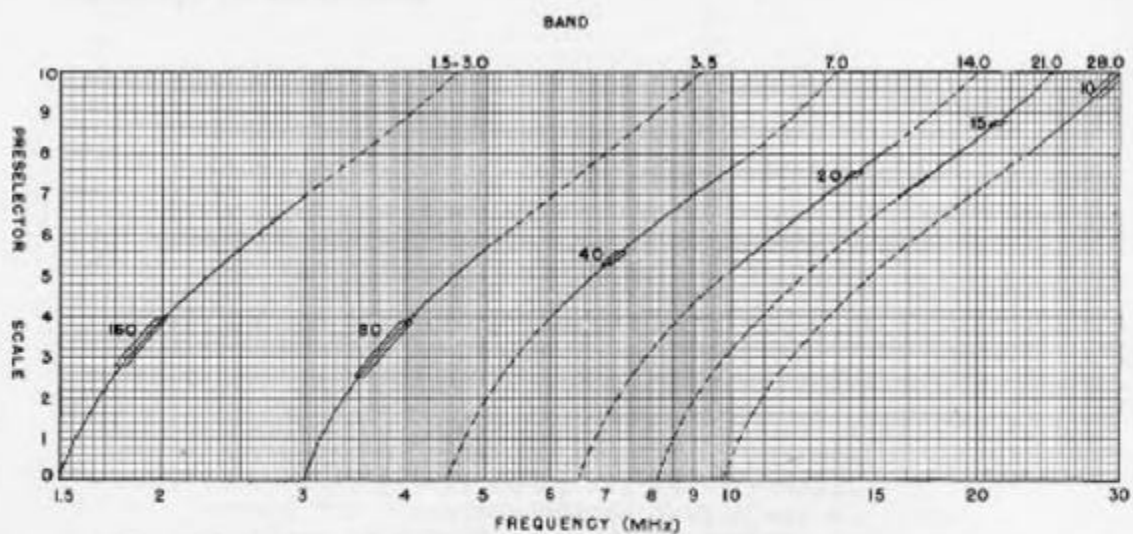

NOTE: SOLID LINE INDICATES RECOMMENDED RANGE FOR EACH BAND.

FIGURE #6 PRESELECTOR TUNING

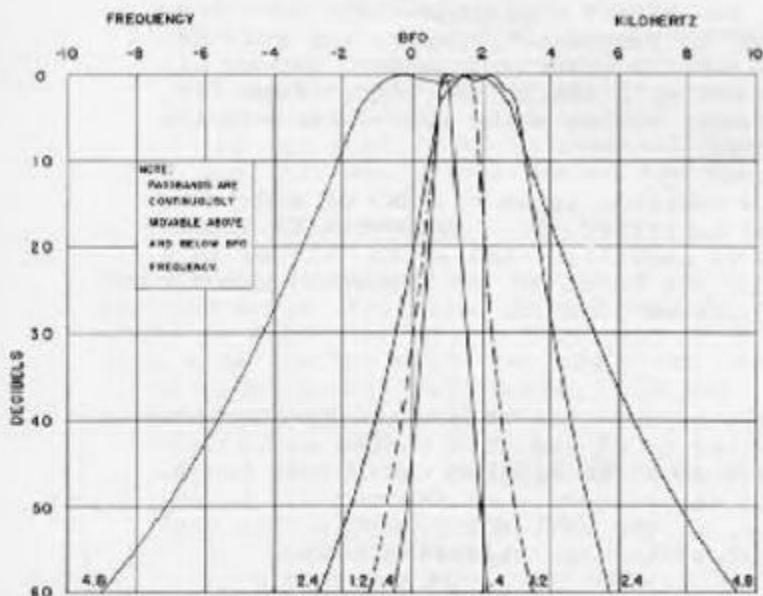

FIGURE #7 -- SELECTIVITY CURVES

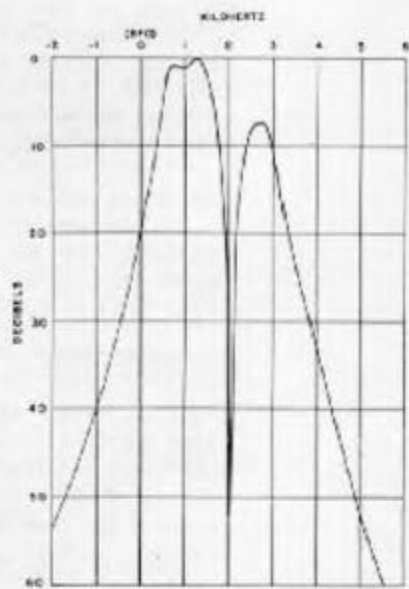

FIGURE #8 -- EFFECT OF NOTCH ON 2.4 KC SELECTIVITY CURVE

SECTION V  
Principles of Operation

to the plate of V5 (the second I.F. amplifier through capacitor C162 and C181. As the amplitude of the signal on the plate of V5 increases, a point is reached at which collector current will flow in Q4, during a portion of each cycle, resulting in an amplified negative voltage being developed across resistor R83.

When the SSB/CW-AM switch is in the FAST AVC position the voltage across R83 will charge capacitor C108. Capacitor C108 then tends to discharge through R83 during the portion of the cycle during which Q4 is cut-off. The time constant of the FAST AVC circuit is approximately 25 milliseconds.

In the SLOW AVC position, the circuit functions the same as for FAST AVC, but capacitor C109 is added to the charging circuit, making the time constant of the circuit approximately 750 milliseconds.

The grids of V1, V4, V5, and V9 are connected to the AVC voltage. Counter-clockwise rotation of the R.F. Gain control increases the negative bias on the AVC-controlled tubes, thus limiting their maximum gain. Isolation of the mute line from ground swings the bias to 30 volts negative, cutting-off the AVC-controlled tubes. The minimum bias of the AVC-controlled tubes is set by receiver sensitivity control R87.

5.9 S-METER

The S-Meter is connected across a bridge circuit which has the plates of V4 and V5 as one arm of the bridge, and the plates of V2 and V3 as the other arm of the bridge. Increasing signal strength results in the application of AVC voltage to the grids of V4 and V5, unbalancing the bridge and causing the S-Meter to deflect up scale. Potentiometer R42 is used to set the bridge balance point, thus determining the zero adjustment of the S-Meter. The current characteristics of the plate circuits of V2 and V3 are such that line voltage variation does not affect the zero setting of the bridge circuit. The sensitivity of the S-Meter is determined by the setting of rheostat R40, which is in series with the S-Meter.

5.10 NOISE BLANKER

The 50 KHz I.F. output of second mixer V3 is coupled into the grid of the noise blanker amplifier (V9) as well as into I. F. amplifier V4. The output of V9 is applied to the grid of the noise shaper (V10A), and the output of V10A is applied to the grid of pulse amplifier V10B. At

SECTION V  
Principles of Operation

normal signal levels, V10A is conducting, but V10B is held cut off by the voltage divider action of R65 and R66, applying positive cathode bias to V10B and diode D3.

When a noise pulse appreciably above the level of the received signal enters V9, a negative-going pulse is applied to the grid of V10A, resulting in a large positive-going pulse at the plate of V10A. This large positive pulse is applied to the grid of V10B, overcoming the bias, and allowing V10B and D3 to conduct. When D3 conducts, the output of the first I. F. amplifier (V4) is shunted to ground through C104 and C105, thus effectively shutting off the receiver during the duration of the noise pulse.

5.11 25 KHz CRYSTAL CALIBRATOR

Transistors Q8, Q9 and integrated circuits IC1 and IC2 are used to provide 25 KHz calibration marks throughout the 2-30 MHz spectrum. Q8 is a stable FET oscillator which provides a 100 KHz signal to the base of the trigger transistor Q9, which drives the integrated circuit frequency dividers. The fast rise time of the integrated circuits provides a signal rich in harmonics, which is coupled to the antenna jack through capacitor C118.

The source of the FET oscillator is disconnected from ground in all but the CAL position of the FUNCTION switch, thus disabling the oscillator.

The calibrator is shipped with calibration signals every 25 KHz. However, it can easily be modified to produce signals only every 100 KHz or every 50 KHz.

To change from 25 KHz to 50 KHz, remove the jumper wire from TP-3 to A and connect from TP-3 to B. To change to 100 KHz calibration points leave the jumper at B and ground point C.



CALIBRATOR PRINTED CIRCUIT BOARD

SECTION V  
Principles of Operation

5.12 POWER SUPPLY

Two 1N3194 diodes are used in a full wave capacitively filtered power supply. A +160 volts is taken directly from the diodes, and a series dropping resistor is used to attain at +150 volts. A third 1N3194 is used to develop a -75 volts bias potential.

5.13 VFO INDICATOR LIGHT

Transistor Q10 is a driver switch for the neon indicator light which illuminates the VFO dial skirt pointer. When the R-4B is used separately, the pointer is illuminated in the ON, EXT. MUTE, XB, and CAL positions providing the shorted phono plug is inserted in the receiver mute jack. When the R-4B is used with the T-4X transmitter, the VFO indicator light comes on when the R-4B is controlling the frequency, provided a slight modification of the T-4X is made. This modification consists of shorting capacitor C154 which is connected to the 6HS6 pre-mixer cathode.

5.14 BLOCK DIAGRAM

A block diagram of the R-4B is presented in Figure 9, page 26.

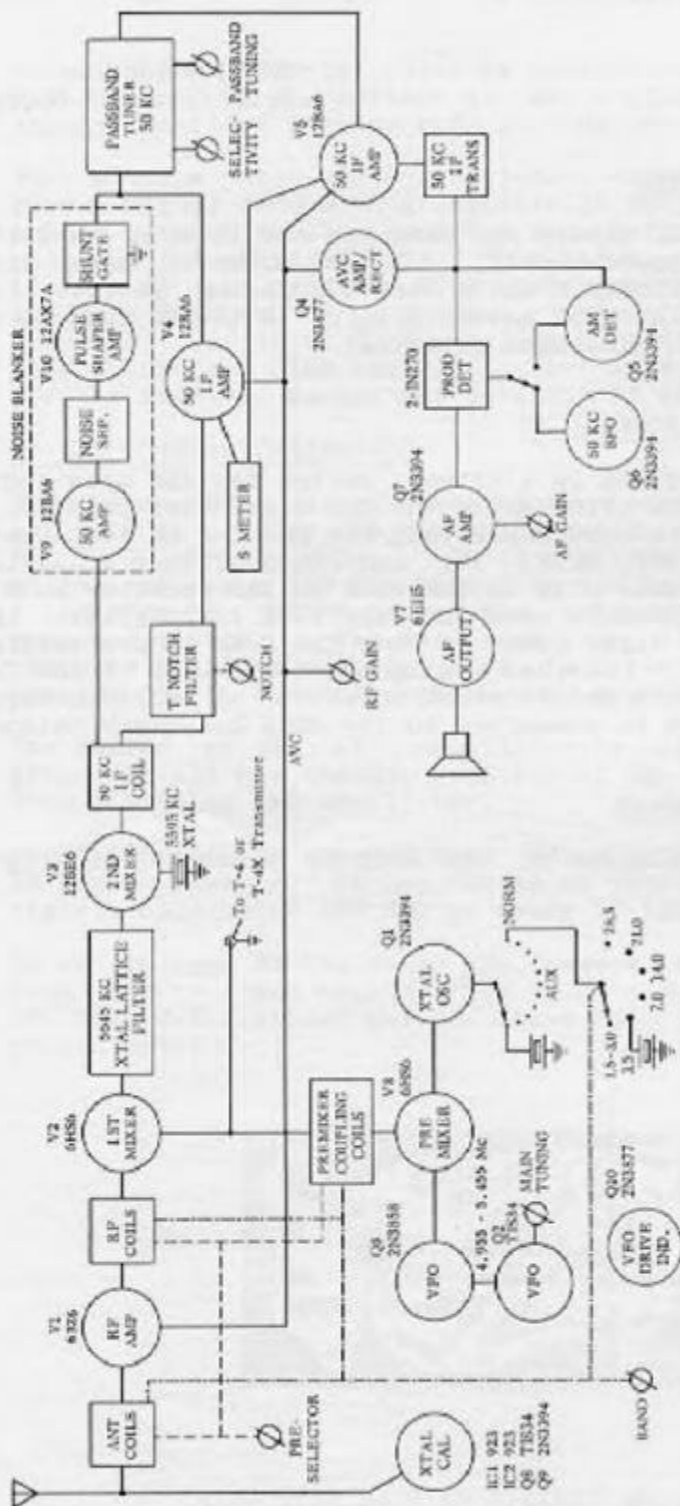

FIGURE #9

SECTION VI  
Servicing

6.1 REMOVING COVERS

1. Remove the three top screws on each side of the R-4B.
2. Remove cover by first pulling up on the rear and then on the front of the cabinet.
3. Remove the six bottom screws from the sides of the R-4B.
4. Lift R-4B chassis out of the bottom cover.

6.2 TUBE REPLACEMENT

In general, most trouble encountered in radio equipment of good design is due to tube failure. The R-4B has been designed so that tube replacement can be done without need for realignment. The best method of finding defective tubes is direct substitution. Do not rely too heavily on a tube checker.

6.3 TROUBLESHOOTING

Careful consideration has been given in the design of the R-4B to keeping maintenance problems to a minimum. However, it is quite possible that some problem will arise which cannot be cured by tube substitution. If this occurs, we suggest that you either return the unit to your dealer, or write direct to our Service Department, describing your problem in detail. Include full information concerning external connections, control settings, tubes substituted, serial number, etc.

DO NOT RETURN EQUIPMENT TO THE FACTORY WITHOUT PRIOR AUTHORIZATION.

The voltage and resistance charts which follow (Figures 10 and 11) should be valuable in isolating minor problems. However, no attempt should be made to service the R-4B unless you are thoroughly familiar with electronic circuitry and servicing technique.

CARE SHOULD BE TAKEN NOT TO DISTURB THE LEAD DRESS IN THE R-4B SINCE THIS IS CRITICAL IN SEVERAL CIRCUITS.

6.4 ALIGNMENT INSTRUCTIONS

Alignment of the R-4B requires use of the following equipment:

1. A stable H.F. signal generator, with variable output, that can be accurately set to any frequency in the range from 1.5 to 30 MHz.
2. A vacuum-tube voltmeter having an input impedance of at least 11 megohms.
3. A 12.6 MHz series resonant crystal.

SECTION VI  
Servicing

VOLTAGE CHART

Tube No. And Type	Pin Number								
	1	2	3	4	5	6	7	8	9
V1(6BZ6)	-1.1	1.7	0	6.3*	140	129	0		
V2(6HS6)	0	0	0	6.3*	140	80	2.8		
V3(12BE6)	-11.5	2.7	12.6*	0	140	132	0		
V4(12BA6)	-1.1	0	0	12.6*	136	84	2		
V5(12BA6)	-1.2	0	12.6*	0	110	70	0		
V7(6EH5)	4.5	0	12.6*	6.3*	0	128	140		
V8(6HS6)	-0.8	0	0	6.3*	145	120	2.2		
V9(12BA6)	-1.3	0	12.6*	0	128	110	0		
V10(12AX7A)	75	-0.5	0	0	12.6*	148	0	4.5	N.C.

\*A.C. Voltage

Conditions of Measurement: Both gain controls fully clockwise.  
SSB/CW-AM set to SLOW AVC. Antenna disconnected. BAND set to  
3.5, PRESELECTOR peaked on noise at 3.5. XTALS set to NORM.  
Shorted plug inserted in mute jack. FUNCTION set to N. B.  
VTVM with 11 megohm input impedance used for measurements.

FIGURE 10.



SECTION VI  
Servicing

RESISTANCE CHART

Tube No. And Type	Pin Number								
	1	2	3	4	5	6	7	8	9
V1(6BZ6)	2.2M	150	0	Fil.	6.5K	6.5K	0		
V2(6HS6)	2.2M	0	Fil.	Fil.	6.5K	228K	2.2K		
V3(12BE6)	150K	330	Fil.	0	6.5K	6.5K	0		
V4(12BA6)	2.2M	0	0	Fil.	6.5K	10K	330		
V5(12BA6)	2.2M	0	Fil.	0	10K	15K	0		
V7(6EH5)	120	700K	Fil.	Fil.	700K	15K	5.5k		
V8(6HS6)	350K	0	0	Fil.	4.7K	12K	500		
V9(12BA6)	1.3M	0	Fil.	0	6.5K	8.3K	0		
V10(12AX7A)	158K	1M	0	0	Fil.	4.5K	3.2M	20K*	Fil.

K = 1,000  
M = 1,000,000

\* Value may vary on different ohmmeter ranges because of characteristics of diode D3.

Conditions of Measurement: Same as given on page 28.

FIGURE 11

SECTION VI  
Servicing

4. An accessory crystal for reception of the WWV standard frequency transmission that is most reliably received in your area. See Table I to determine crystal frequency required.
5. An alignment load consisting of a 1000 ohm  $\frac{1}{2}$  watt composition resistor connected in series with a 0.005 microfarad disc ceramic capacitor. Small alligator clips on the ends of the component leads will make this convenient to use.
6. Two 10,000 ohm resistors and one 68 ohm resistor, all  $\frac{1}{2}$  watt.
7. A scale with accurate 1/32 inch divisions.

The R-4B should be turned on and allowed to warm up for at least one-half hour before alignment is begun.

6.4.1 25 KHz CALIBRATOR

1. Connect the antenna to the R-4B, and set the receiver controls for AM reception of WWV. Tune in WWV.
2. Refer to Figure 13 and determine the location of C119.
3. Insert a shorted plug in the MUTE jack, and set the FUNCTION switch to CAL.
4. Adjust the audio gain until you can hear the beat note between WWV and the calibration signal.
5. Adjust C119 for zero beat with the WWV signal.

6.4.2 50 KHz OSCILLATOR

1. See Figure 13, and determine the location of T11.
2. Set the SSB/CW-AM switch to FAST AVC and set the FUNCTION switch to CAL.
3. Connect alignment load from Pin 5 of V5 to TP-3 on 25 KHz calibrator printed circuit board.
4. Turn up the audio gain to make the beat note audible.
5. Adjust T11 for zero beat, then disconnect the alignment load.

6.4.3 50 KHz I.F.

1. Refer to Figures 12 and 13, and determine the locations of V3, T7, T10, T14, and TP-1.
2. Set the PASSBAND lever to 4.8, and align the white line in the PASSBAND tuning knob with the midpoint of the longest curved line above the knob.
3. Connect the signal generator to pin 7 of V3 and adjust the frequency of the generator toward 5645 KHz. As the frequency approaches 5645 KHz a beat note will be heard. Adjust the generator frequency for zero beat.

SECTION VI  
Servicing

4. Adjust the signal generator output to give an S-Meter reading of S-9. Adjust T7 and T10 for maximum S-Meter reading. Since the tuning of T7 and T10 is quite broad, it is suggested that you determine the range within which maximum output is realized from each, and then set the tuning to the middle of this range.
5. Connect the VTVM to TP-1 and adjust T14 for maximum positive voltage.

6.4.4 CRYSTAL FILTER AND FILTER MATCH TRANSFORMER

1. Adjust the signal generator to 5645 KHz, connect the output of the generator to pin 1 of V2, and adjust the signal generator output to give an S-Meter reading of S-9.
2. Set the PASSBAND selector lever to 2.4. Turn the PASSBAND knob to the left until the white line in the knob is aligned with the dot below the end of the longest curved line on the panel.
3. Adjust the signal generator frequency for a peak S-Meter reading, then adjust the signal generator output level to give a reading of S-9. A high-pitched audio tone should be heard.
4. Adjust the signal generator frequency in the direction that causes the audio tone to become higher in pitch. Continue adjusting the frequency in the same direction until the S-Meter reading falls to S-3 (a decrease of 20 dB).
5. Adjust T5 and T6 (See Figures 12 and 13) for maximum S-Meter reading.
6. Set PASSBAND selector lever to 4.8, and set the PASSBAND knob so the line in the knob is at the center of the longest curved line on the panel.
7. Set the signal generator frequency to 5545 KHz (the image frequency) and adjust the generator output level until a signal is heard.
8. At the base of the crystal filter can, you will note two wires which are wrapped around pins. Gradually twist one of these wires tighter until minimum signal is heard. If the signal level increases, the wrong wire is being twisted. Turn the wire to its original configuration and twist the other wire. If much adjustment is needed to minimize the signal, steps 1 through 5 should be repeated after completing this step.

6.4.5 5595 KHz OSCILLATOR

1. Set PASSBAND selector lever to 4.8 and align the line in the PASSBAND knob with the midpoint of the longest curved line on the panel.

SECTION VI  
Servicing

2. Connect the signal generator to pin 1 of V2, and the VTVM to TP-1. Adjust the generator frequency for maximum positive voltage indication on the VTVM. (The generator frequency should be approximately 5645 KHz).
3. Note the voltage reading on the VTVM. Decrease the signal generator frequency until the indicated voltage is one-half as much as first noted, and record the generator frequency. Increase the generator frequency until the voltmeter indication passes through the peak and again falls to one-half the peak value. Note the generator frequency.
4. Set the signal generator frequency exactly half-way between the low and high frequencies found in step 3. Now adjust C-6I (See Figure 12) for zero beat.

NOTE: When the R-4B is used in transceive operation with the T-4 or T-4X, a more precise adjustment of C-6I is required. Instructions for making this adjustment are given in the T-4/T-4X instruction manual.

6.4.6 ANTENNA, R.F., AND INJECTION CIRCUITS

1. Turn off the receiver. Refer to Figure 13 and determine the location of S5C and S5D (these are the third and fourth bandswitch wafers, counting from the front of the receiver). Locate these switch wafers in the receiver. Each of these switch wafers has two rotor contacts, and they are colored green. Connect a 10,000 ohm resistor from the more easily accessible of the two rotor contacts on S5C to ground. From the corresponding rotor contact of S5D, connect a 10,000 ohm resistor to H+. The easiest point to make this connection is to the red and white striped wire on the terminal strip near S5D.
2. Disconnect the antenna from the R-4B, and connect a 68 ohm resistor from the center of the antenna jack to ground.
3. Plug the 12.6 MHz crystal into one of the accessory crystal sockets.
4. Set the receiver right-side up on the bench, and turn the PRESELECTOR knob as far clockwise as possible. Carefully measure the distance from the top of the slug of T1 to the top of the white liner projecting through the hole in the top of T1. The distance was set at the factory to exactly 9/16 inch. Check the measurement carefully before altering the position of the slug. The distance that the slug projects must be exactly 9/16 inch. Check the setting of the slugs in T2, T3, and T4. All must have the same 9/16 inch projection.

SECTION VI  
Servicing

5. Turn the receiver on, set the BAND switch to 28.5, the FUNCTION switch to CAL., and tune in the calibrator signal at 28.5 MHz. Allow the receiver to warm up a few minutes.
6. Adjust the PRESELECTOR knob so the slugs in T1 through T4 project exactly 15/32 inch above the white liners.
7. Adjust the four trimmers marked 28.0 (See Figure 12) for maximum S-Meter reading. NOTE: If the calibrator signal is insufficient to produce an adequate S-Meter indication, remove the 68 ohm resistor from the antenna input, and connect the signal generator to the antenna input. Set the R-4B FUNCTION switch to EXT. MUTE, adjust the signal generator to 28.5 MHz, and set the generator output level to cause an S-Meter indication of approximately S-7. Then adjust the 28.0 trimmers for maximum S-Meter indication.
8. Repeat steps 6 and 7 for each band, using the settings given below:

<u>BAND</u>	<u>SLUG HEIGHT</u>	<u>FREQUENCY</u>
21.0	7/16 inch	21.3 MHz
14.0	11/32 inch	14.3 MHz
7.0	3/16 inch	7.3 MHz
3.5	Flush with white sleeve	3.8 MHz
1.5	Flush with white sleeve	1.9 MHz

NOTE: For the 1.5 band, the XTALS switch must be set to the position corresponding to the number of the socket into which the 12.6 MHz crystal was inserted.

9. This alignment is now complete. Turn off the R-4B, and remove the alignment resistors.

#### 6.4.7 NOTCH FILTER

1. Turn the receiver on, and set the FUNCTION switch to CAL.
2. Tune in the calibrator signal, at any frequency, and adjust the tuning for zero beat.
3. Set the NOTCH control knob to the midpoint of its adjustment range.
4. Adjust the slug in T8 (See Figure 12) for minimum S-Meter reading.

#### 6.4.8 PASSBAND TUNER

1. See Figures 4 and 12 for identification of the pass-band tuner.

SECTION VI  
Servicing

2. Turn the PASSBAND tuning knob through one complete revolution while observing the movement of the four slugs visible at the rear of the passband tuner. Adjust the knob to the position in which the slugs are furthest toward the rear of the receiver.
3. The white line in the PASSBAND tuning knob should be pointing horizontally to the left, as viewed from in front of the receiver. If it is not, loosen the set screw in the knob, and reposition the knob being careful not to change the adjustment of the passband tuner itself.
4. Set the BAND switch to 3.5, XTALS to NORM, and the FUNCTION switch to CAL. Tune in the calibration signal at 3.8 MHz, and adjust for zero beat.
5. Set the PASSEBAND selector lever to .4, and the PASSBAND tuning knob to the midpoint of the shortest of the curved lines on the panel.
6. Connect the VTVM to TP-2 (See Figure 12), and adjust the four slugs in the passband tuner for maximum negative voltage. These slugs have a tendency to spring back after being turned, so care must be exercised to be sure the setting giving maximum voltage is made.
7. Turn the FUNCTION switch to EXT. MUTE, and rotate the PASSBAND knob so the line in the knob is pointing horizontally to the left. Note the pitch of the sound coming from the receiver. Move the PASSBAND control knob so the line in the knob is pointing horizontally to the right, and note the pitch of the sounds heard. If the sound at these two positions of the PASSBAND knob are not the same, adjust the small screw near the center of the rear cover of the passband tuner assembly until the sound does have the same pitch at these two settings of the control.
8. Set the PASSEBAND selector lever to 2.4. Set the index line in the PASSBAND control knob to the dot at the left end of the second longest of the curved lines, then to the dot at the right end of the same line. The pitch of the sound heard at these two settings should be the same. If not, return the setting to the left dot, note the pitch, and turn the knob clockwise until the same pitch is reached. Then loosen the set screw in the knob, and move the knob until it is halfway between the equal pitch position and the dot at the right end of the curved line. Tighten the screw in the knob. Be careful not to change the position of the passband tuner shaft while re-positioning the control knob.

SECTION VI  
Servicing

6.4.9 BIAS AND S-METER

1. Set the VTVM to read negative d.c. volts, and connect it from TP-2 to chassis.
2. With no antenna connected, and with the BAND switch and PRESELECTOR set to different ranges to assure complete detuning, adjust the receiver sensitivity control (See Figure 13) until the voltmeter indicates -1.35 volts.
3. Disconnect the voltmeter, and adjust the S-Meter zero control (See Figure 12) to give an S-Meter reading of S-1.
4. Reconnect the voltmeter to TP-2 and set the R.F. GAIN control counter-clockwise until -15 volts is read. Adjust the S-Meter sensitivity control (See Figure 13) for an S-Meter reading of 40 dB over S-9.
5. Repeat steps 3 and 4, as some interaction of the two control settings may occur.

Factory alignment of your R-48 will be performed for \$10.00 plus transportation charges, provided the set has not been tampered with. Misaligned or damaged sets will be repaired on a time and material basis only.

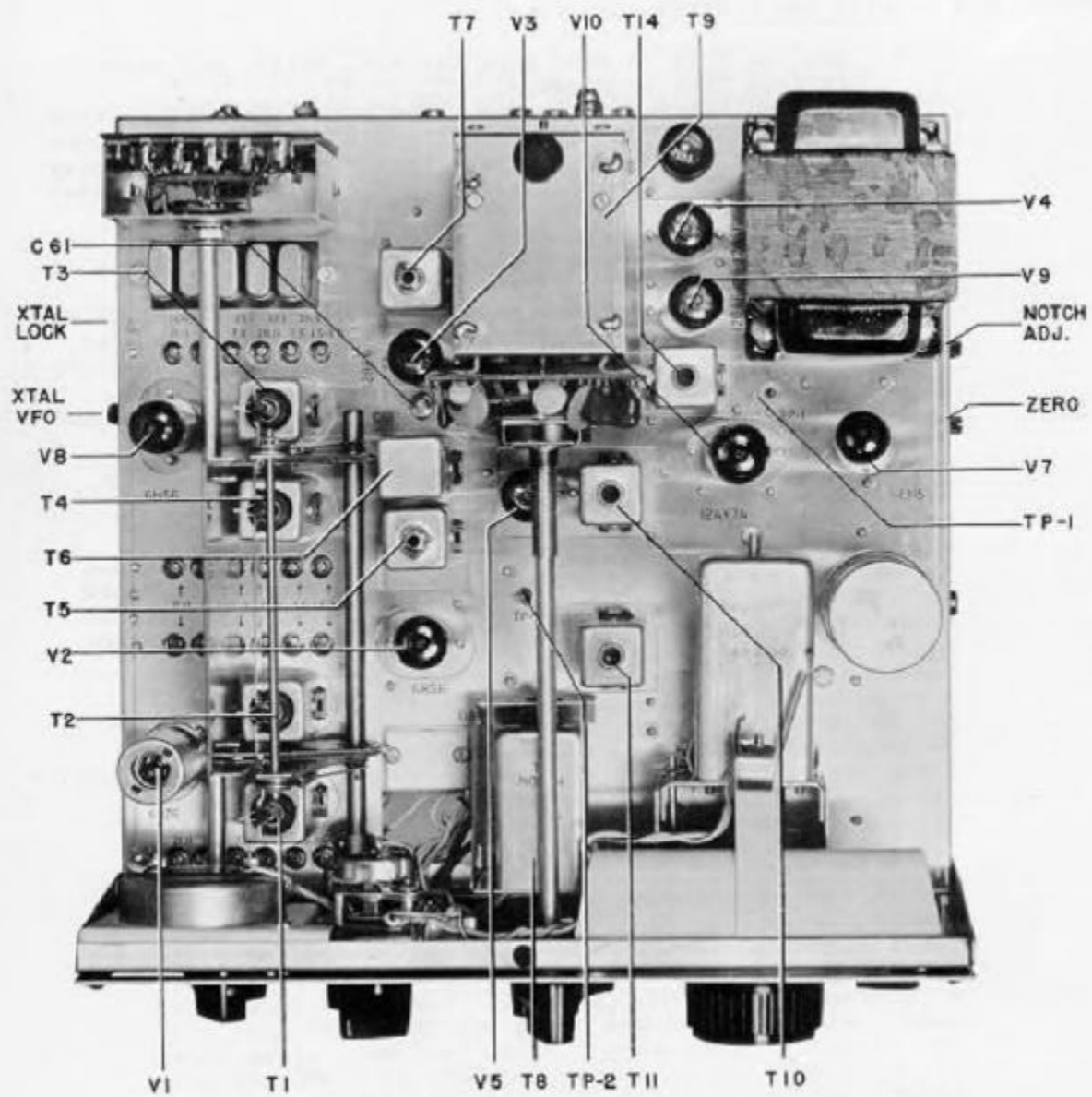

FIGURE#12 TOP VIEW



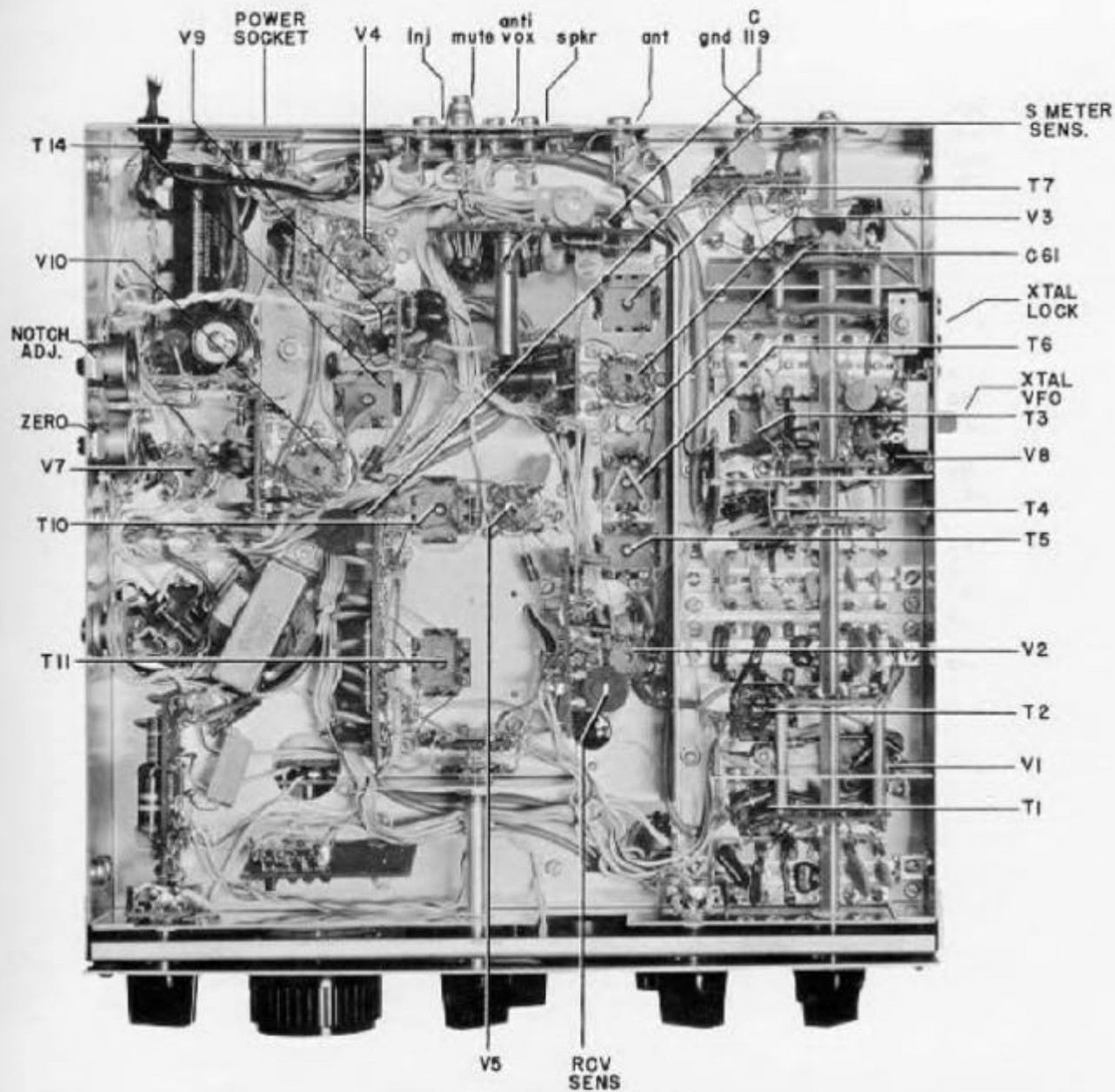
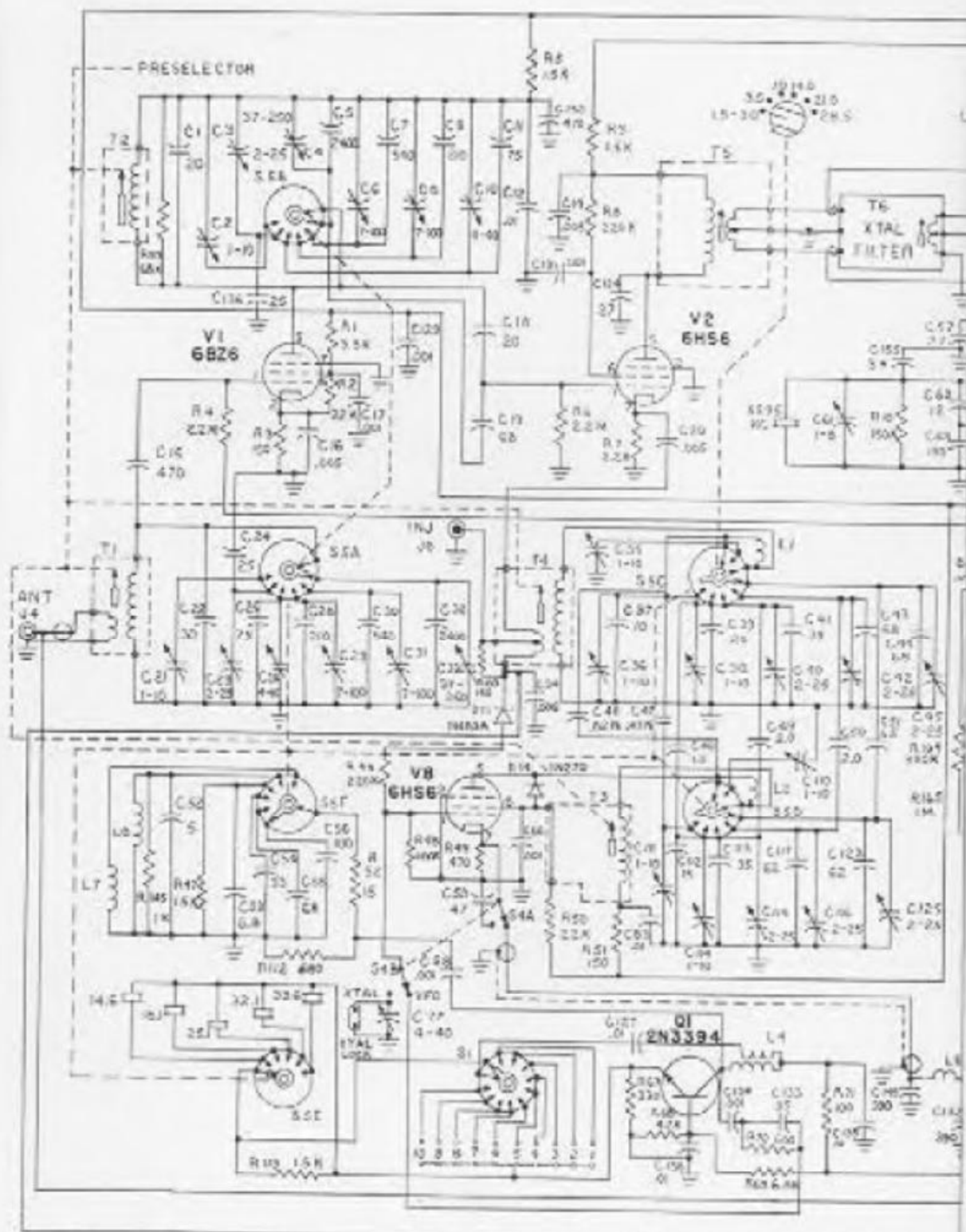

FIGURE #13 BOTTOM VIEW



**NOTES**

- Capacitors marked 10 to 3000 are in pf. and capacitors from .001 to .47 are in  $\mu$ f. units
- Resistors in VPO are 1/4 watt 10%. All others are 1/2 watt 10% unless otherwise
- \* indicates value selected in production.
- All switches viewed from front in counterclockwise position.
- Highest resistor R 1/4 Highest capacitor 0.20?

